



**PNOZ m ES EtherNet/IP**



**pilz**

Configurable Control System PNOZmulti

This document is the original document.

All rights to this documentation are reserved by Pilz GmbH & Co. KG. Copies may be made for internal purposes. Suggestions and comments for improving this documentation will be gratefully received.

Pilz®, PIT®, PMI®, PNOZ®, Primo®, PSEN®, PSS®, PVIS®, SafetyBUS p®, SafetyEYE®, SafetyNET p®, the spirit of safety® are registered and protected trademarks of Pilz GmbH & Co. KG in some countries.



SD means Secure Digital

<b>Section 1</b>	<b>Introduction</b>	<b>5</b>
	1.1 Validity of documentation	5
	1.2 Using the documentation	5
	1.3 Definition of symbols	5
<b>Section 2</b>	<b>Overview</b>	<b>7</b>
	2.1 Scope of supply	7
	2.2 Unit features	7
	2.3 Front view	7
<b>Section 3</b>	<b>Safety</b>	<b>9</b>
	3.1 Intended use	9
	3.2 System requirements	9
	3.3 Safety regulations	10
	3.3.1 Use of qualified personnel	10
	3.3.2 Warranty and liability	10
	3.3.3 Disposal	10
	3.3.4 For your safety	10
<b>Section 4</b>	<b>Function description</b>	<b>11</b>
	4.1 Operation	11
	4.2 Data exchange	11
	4.3 Input and output data	11
	4.4 Block diagram	12
<b>Section 5</b>	<b>Installation</b>	<b>13</b>
	5.1 General installation guidelines	13
	5.2 Connect the base unit and expansion modules	13
	5.3 Dimensions	13
<b>Section 6</b>	<b>Commissioning</b>	<b>14</b>
	6.1 General wiring guidelines	14
	6.2 Connecting the supply voltage	14
	6.3 Interface assignment	15
	6.4 Download modified project to the PNOZmulti safety system	15
	6.5 Set IP address	15
	6.6 Connection example	17
<b>Section 7</b>	<b>Operation</b>	<b>18</b>
	7.1 Messages	18
	7.2 Web server	19
	7.2.1 Password administration	19
	7.2.2 Call web server	20
<b>Section 8</b>	<b>Technical Details</b>	<b>21</b>
<b>Section 9</b>	<b>Order reference</b>	<b>23</b>

---

9.1	Module	23
9.2	Accessories	23

---

# 1 Introduction

## 1.1 Validity of documentation

This documentation is valid for the product PNOZ m ES EtherNet/IP. It is valid until new documentation is published.

This operating manual explains the function and operation, describes the installation and provides guidelines on how to connect the product.

## 1.2 Using the documentation

This document is intended for instruction. Only install and commission the product if you have read and understood this document. The document should be retained for future reference.

## 1.3 Definition of symbols

Information that is particularly important is identified as follows:



### **DANGER!**

This warning must be heeded! It warns of a hazardous situation that poses an immediate threat of serious injury and death and indicates preventive measures that can be taken.



### **WARNING!**

This warning must be heeded! It warns of a hazardous situation that could lead to serious injury and death and indicates preventive measures that can be taken.



### **CAUTION!**

This refers to a hazard that can lead to a less serious or minor injury plus material damage, and also provides information on preventive measures that can be taken.



### **NOTICE**

This describes a situation in which the product or devices could be damaged and also provides information on preventive measures that can be taken. It also highlights areas within the text that are of particular importance.



**INFORMATION**

This gives advice on applications and provides information on special features.

## 2 Overview

### 2.1 Scope of supply

### 2.2 Unit features

Using the product PNOZ m ES EtherNet/IP:

Expansion module for connection to a base unit from the configurable control system PNOZmulti 2 .

The product has the following features:

- ▶ Can be configured in the PNOZmulti Configurator
- ▶ Connection for EtherNet/IP as adapter
- ▶ Transmission rate 10 MBit/s (10BaseT) and 100 MBit/s (100BaseTX)
- ▶ Status indicators for communication and for errors
- ▶ 128 virtual inputs and outputs on the control system PNOZmulti can be defined in the PNOZmulti Configurator for communication with the fieldbus EtherNet/IP.
- ▶ Max. 1 PNOZ m ES EtherNet/IP can be connected to the base unit
- ▶ 2-port switch
- ▶ Device Level Ring (DLR)
- ▶ Integrated web server
- ▶ For details of the PNOZmulti 2 base units that can be connected, please refer to the document "PNOZmulti System Expansion".

### 2.3 Front view

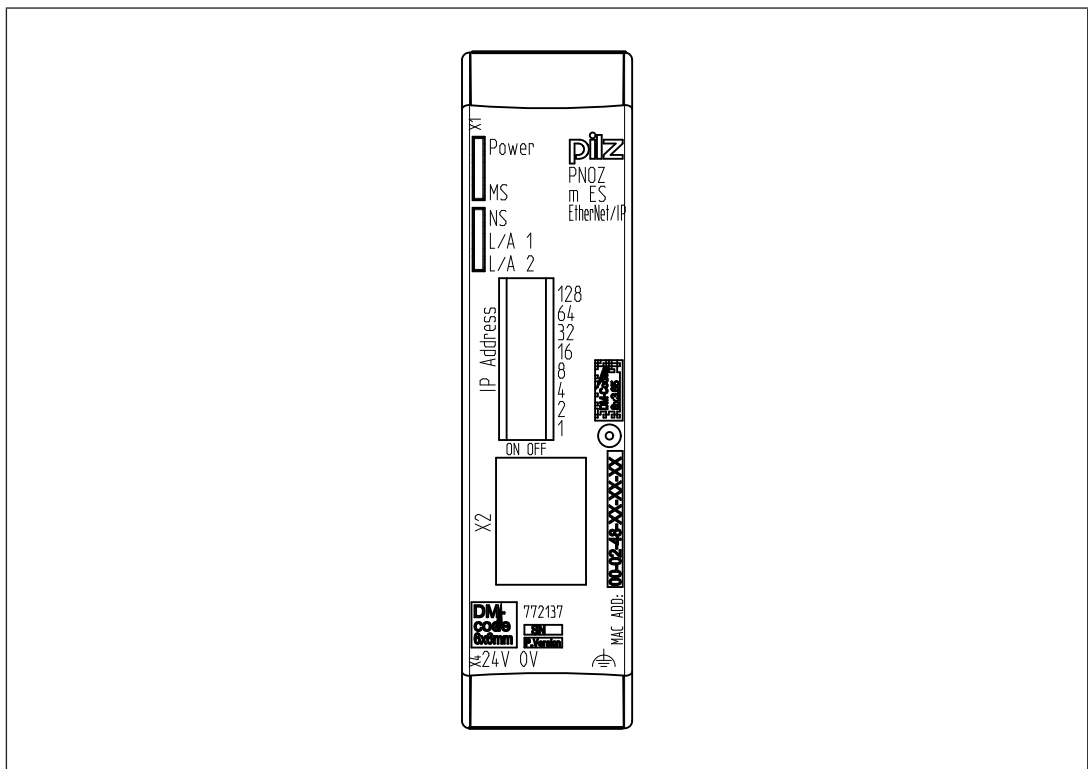

**Legend:**

- ▶ X1, X2: EtherNet/IP - Interfaces
- ▶ 0 V, 24 V: Supply connections
- ▶ IP address: for setting the IP address
- ▶ : Functional earth
- ▶ LED:
  - Power
  - MS
  - NS
  - L/A 1
  - L/A 2

EtherNet/IP™ is registered trademark and patented technology, licensed by ODVA.



## 3 Safety

### 3.1 Intended use

The fieldbus module PNOZ m ES EtherNet/IP is an expansion module of the configurable control system PNOZmulti 2. It is used for communication between the configurable control system PNOZmulti 2 and EtherNet/IP. EtherNet/IP is designed for fast data exchange at field level. The expansion module PNOZ m ES EtherNet/IP is a passive subscriber (Adapter) of the EtherNet/IP. The basic functions of communication with EtherNet/IP conform to IEEE 802.3. The central controller (scanner) reads input information from the slaves and writes output information to the slaves as part of each cycle. As well as the cyclical transfer of usable data, the expansion module PNOZ m ES EtherNet/IP can also be used for diagnostic and commissioning functions.

The expansion module may only be connected to a base unit from the configurable control system PNOZmulti (please refer to the document "PNOZmulti System Expansion" for details of the base units that can be connected)

The configurable control system PNOZmulti is used for the safety-related interruption of safety circuits and is designed for use in:

- ▶ E-STOP equipment
- ▶ Safety circuits in accordance with VDE 0113 Part 1 and EN 60204-1

The expansion module may not be used for safety-related functions.

The following is deemed improper use in particular:

- ▶ Any component, technical or electrical modification to the product
- ▶ Use of the product outside the areas described in this manual
- ▶ Use of the product outside the technical details (see chapter entitled "Technical Details").



#### **NOTICE**

##### EMC-compliant electrical installation

The product is designed for use in an industrial environment. The product may cause interference if installed in other environments. If installed in other environments, measures should be taken to comply with the applicable standards and directives for the respective installation site with regard to interference.

### 3.2 System requirements

Please refer to the "Product Modifications" document in the "Version overview" section for details of which versions of the base unit and PNOZmulti Configurator can be used for this product.

## 3.3 Safety regulations

### 3.3.1 Use of qualified personnel

The products may only be assembled, installed, programmed, commissioned, operated, maintained and decommissioned by competent persons.

A competent person is someone who, because of their training, experience and current professional activity, has the specialist knowledge required to test, assess and operate the work equipment, devices, systems, plant and machinery in accordance with the general standards and guidelines for safety technology.

It is the company's responsibility only to employ personnel who:

- ▶ Are familiar with the basic regulations concerning health and safety / accident prevention
- ▶ Have read and understood the information provided in this description under "Safety"
- ▶ And have a good knowledge of the generic and specialist standards applicable to the specific application.

### 3.3.2 Warranty and liability

All claims to warranty and liability will be rendered invalid if

- ▶ The product was used contrary to the purpose for which it is intended
- ▶ Damage can be attributed to not having followed the guidelines in the manual
- ▶ Operating personnel are not suitably qualified
- ▶ Any type of modification has been made (e.g. exchanging components on the PCB boards, soldering work etc.).

### 3.3.3 Disposal

- ▶ When decommissioning, please comply with local regulations regarding the disposal of electronic devices (e.g. Electrical and Electronic Equipment Act).

### 3.3.4 For your safety

The unit meets all the necessary conditions for safe operation. However, you should always ensure that the following safety requirements are met:

- ▶ This operating manual only describes the basic functions of the unit. The expanded functions are described in the PNOZmulti Configurator's online help. Only use these functions once you have read and understood the documentations.
- ▶ Do not open the housing or make any unauthorised modifications.
- ▶ Please make sure you shut down the supply voltage when performing maintenance work (e.g. exchanging contactors).

## 4 Function description

### 4.1 Operation

The virtual inputs and outputs that are to be transferred via the fieldbus EtherNet/IP are selected and configured in the PNOZmulti Configurator. The base unit and the fieldbus module PNOZ m ES EtherNet/IP are connected via a jumper. After the supply voltage is switched on or the PNOZmulti control system is reset, the fieldbus module PNOZ m ES EtherNet/IP is configured and started automatically.

LEDs indicate the status of the fieldbus module EtherNet/IP.

The configuration is described in detail in the PNOZmulti Configurator's online help.



#### INFORMATION

The ESD file is available on the Internet at [www.pilz.de](http://www.pilz.de).

### 4.2 Data exchange

17 or 32 bytes must always be sent and received for communication with the PNOZmulti.

Fixed parameters for the input/output assembly instances are set in the fieldbus module PNOZ m ES EtherNet/IP. The following data lengths can be selected:

Assembly Instance Input	Data length	Description
100	32 Bytes	Inputs, LEDs, tables
101	17 Bytes	Inputs, LEDs

Assembly Instance Output	Data length	Description
150	32 Bytes	Outputs, LEDs, tables
151	17 Bytes	Outputs, LEDs

Assembly Instance Configuration	Data length	Description
4	0 Bytes	-

### 4.3 Input and output data

The data is structured as follows:

#### Input area

The inputs are defined in the master and transferred to the PNOZmulti. Each input has a number, e.g. input bit 4 of byte 1 has the number I12.

Virtual inputs PNOZmulti Configurator	I0 ... I7	I8 ... I15	I16 ... I23	...	I120...I127
EtherNet/IP	Byte 0: Bit 0 ... 7	Byte 1: Bit 0 ... 7	Byte 2: Bit 0 ... 7	...	Byte 15: Bit 0 ... 7

**Output range**

The outputs are defined in the PNOZmulti Configurator. Each output that is used is given a number there, e.g. O0, O5... .

The status of output O0 is stored in bit 0 of byte 0; the status of output O5 is stored in bit 5 of byte 0 etc.

Virtual inputs PNOZmulti Configurator	O0 ... O7	O8 ... O15	O16 ... O23	...	O120... O127
EtherNet/IP	Byte 0: Bit 0 ... 7	Byte 1: Bit 0 ... 7	Byte 2: Bit 0 ... 7	...	Byte 15: Bit 0 ... 7

- ▶ Bit 0 ... 4: Status of LEDs on the PNOZmulti 2
  - Bit 0: OFAULT
  - Bit 1: IFAULT
  - Bit 2: FAULT
  - Bit 3: DIAG
  - Bit 4: RUN
- ▶ Data exchange is displayed in Bit 5.
- ▶ Polling the payload data: 2 Bytes with the table number and segment number are sent by the Master for access to the payload data table (15 Bytes are returned to the Master).

Detailed information on data exchange is available in the document "Communication Interfaces PNOZmulti 2" in the section entitled "Fieldbus modules".

**4.4 Block diagram**

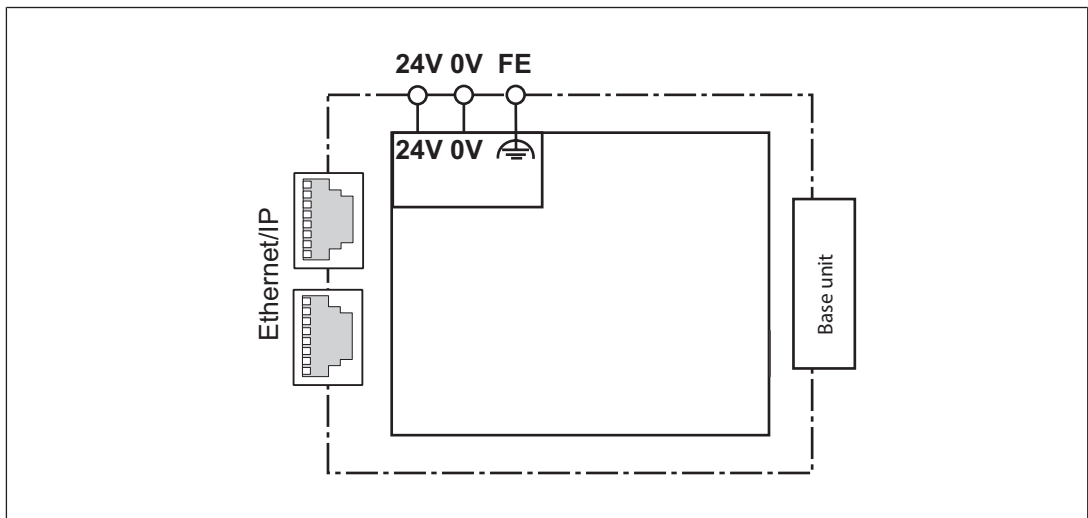

## 5 Installation

### 5.1 General installation guidelines

- ▶ The unit should be installed in a control cabinet with a protection type of at least IP54.
- ▶ Fit the safety system to a horizontal mounting rail. The venting slots must face upward and downward. Other mounting positions could damage the safety system.
- ▶ Use the locking elements on the rear of the unit to attach it to a mounting rail.
- ▶ In environments exposed to heavy vibration, the unit should be secured using a fixing element (e.g. retaining bracket or end angle).
- ▶ Open the locking slide before lifting the unit from the mounting rail.
- ▶ To comply with EMC requirements, the mounting rail must have a low impedance connection to the control cabinet housing.
- ▶ The ambient temperature of the PNOZmulti units in the control cabinet must not exceed the figure stated in the technical details, otherwise air conditioning will be required.



#### NOTICE

Damage due to electrostatic discharge!

Electrostatic discharge can damage components. Ensure against discharge before touching the product, e.g. by touching an earthed, conductive surface or by wearing an earthed armband.

### 5.2 Connect the base unit and expansion modules

Connect the base unit and the expansion module as described in the operating instructions for the base units.

- ▶ Connect the black/yellow terminator to the expansion module.
- ▶ Install the expansion module in the position in which it is configured in the PNOZmulti Configurator.

### 5.3 Dimensions

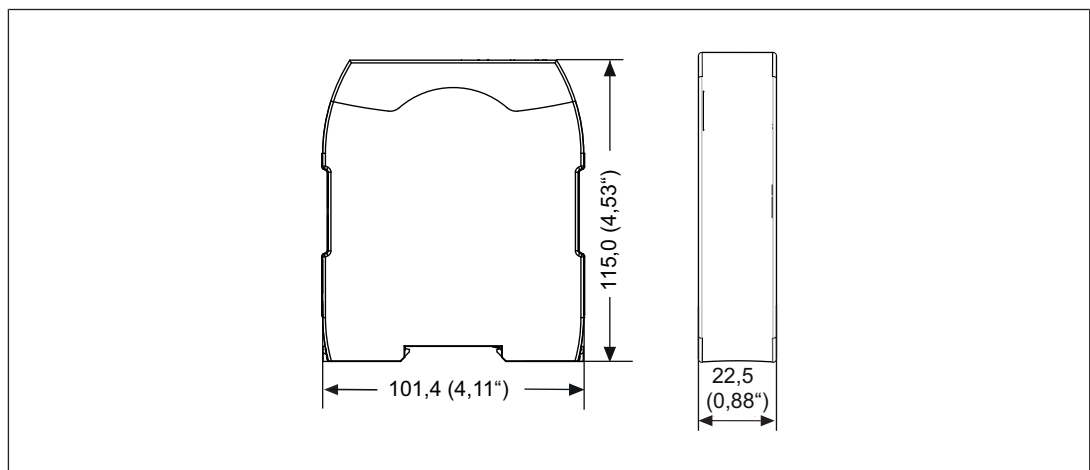

## 6 Commissioning

### 6.1 General wiring guidelines

The wiring is defined in the circuit diagram of the PNOZmulti Configurator. It is possible to define which inputs and outputs on the safety system will communicate with EtherNet/IP.

Please note:

- ▶ Information given in the "Technical details" must be followed.
- ▶ Use copper wiring with a temperature stability of 75 °C.

Please note the following when connecting to EtherNet/IP:

- ▶ The following minimum requirements of the connection cable and connector must be met:
  - Only use standard industrial Ethernet cable and connectors.
  - Only use double-shielded twisted pair cable and shielded RJ45 connectors (industrial connectors).
  - 100BaseTX cable in accordance with the Ethernet standard (min. Category 5)
- ▶ Measures to protect against interference:  
Ensure the requirements for the industrial use of EtherNet/IP are met, as stated in the Installation Manual published by the User Group.
- ▶ External measures must be used to connect the terminal  to the functional earth, when the mounting rail is **not** connected to the functional earth.
- ▶ Always connect the mounting rail to the protective earth via an earthing terminal. This will be used to dissipate hazardous voltages in the case of a fault.
- ▶ The power supply must meet the regulations for extra low voltages with protective separation.



#### CAUTION!

Only connect and disconnect the expansion module when the supply voltage is switched off.



#### NOTICE

When installing, you must refer to the guidelines of the EtherNet/IP User Group.

### 6.2 Connecting the supply voltage

Connect the supply voltage to the fieldbus module:

- ▶ Terminal **24 V**: + 24 V DC
- ▶ Terminal **0 V**: 0 V

## 6.3 Interface assignment

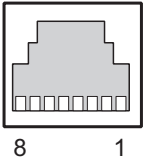
RJ45 socket 8-pin	PIN	Standard
	1	TD+ (Transmit+)
	2	TD- (Transmit-)
	3	RD+ (Receive+)
	4	n.c.
	5	n.c.
	6	RD- (Receive-)
	7	n.c.
	8	n.c.

n.c.: Not connected

## 6.4 Download modified project to the PNOZmulti safety system

As soon as an additional expansion module has been connected to the system, the project must be amended using the PNOZmulti Configurator. Proceed as described in the operating instructions for the base unit.



### NOTICE

For the commissioning and after every program change, you must check whether the safety devices are functioning correctly.

## 6.5 Set IP address

The IP address of the fieldbus module PNOZ m ES EtherNet/IP is set using the DIP switch on the front.

- ▶ The first three bytes of the IP address are: 192.168.1.
- ▶ Subnet mask: 255.255.255.0.
- ▶ The last byte of the IP address is configured (value range: 1 ...255).



### INFORMATION

The IP address should **only** be set when the fieldbus module PNOZ m ES EtherNet/IP is switched off (no voltage applied).

The settings are **only** transferred when booting. Any changes made to the settings during operation will **not** be transferred.



**INFORMATION**

Type and source of danger

The IP address for the fieldbus module PNOZ m ES EtherNet/IP should not be the same as the PC's IP address.

There are various options for setting the IP address.

- ▶ Use of the DHCP Server is enabled  
 DHCP is automatically enabled on a new module. In this case the IP address is taken from the DHCP Server, if the DIP switch is set to 0. The module waits to receive an address from a DHCP Server.
- ▶ If a fixed IP address has been assigned via the web server or by the EtherNet/IP scanner, then this will be used. The DIP switch must be set to zero for this purpose.
- ▶ Setting via the DIP switch  
 The IP address that is set at the DIP switch is used. DHCP is therefore disabled.  
 Set the DIP switch to a value between 1 – 254.
- ▶ Enable DHCP via DIP switch  
 If you set the DIP switch to 255, then DHCP will always be used, irrespective of the configuration in the web server.

Example: DIP switch: 00010100 (20 decimal)

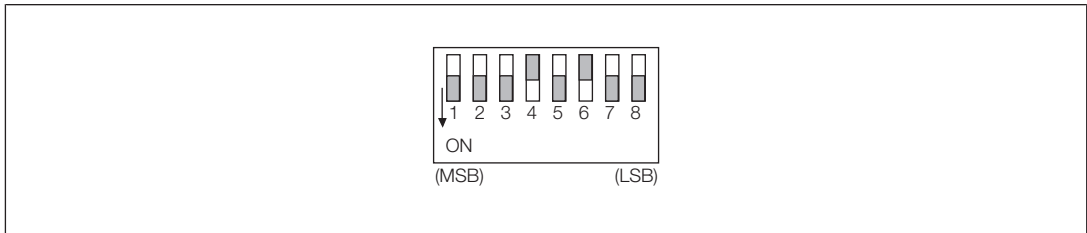

Fig.: DIP switch setting: 20 (decimal) as the value for the last byte of the IP address

DIP switch "IP address"	Meaning		Example: IP address 020 <sub>D</sub>
	OFF	ON	
1	0	128 <sub>D</sub>	
2	0	64 <sub>D</sub>	
3	0	32 <sub>D</sub>	
4	0	16 <sub>D</sub>	
5	0	8 <sub>D</sub>	
6	0	4 <sub>D</sub>	
7	0	2 <sub>D</sub>	
8	0	1 <sub>D</sub>	

DIP switch IP address



## 6.6 Connection example

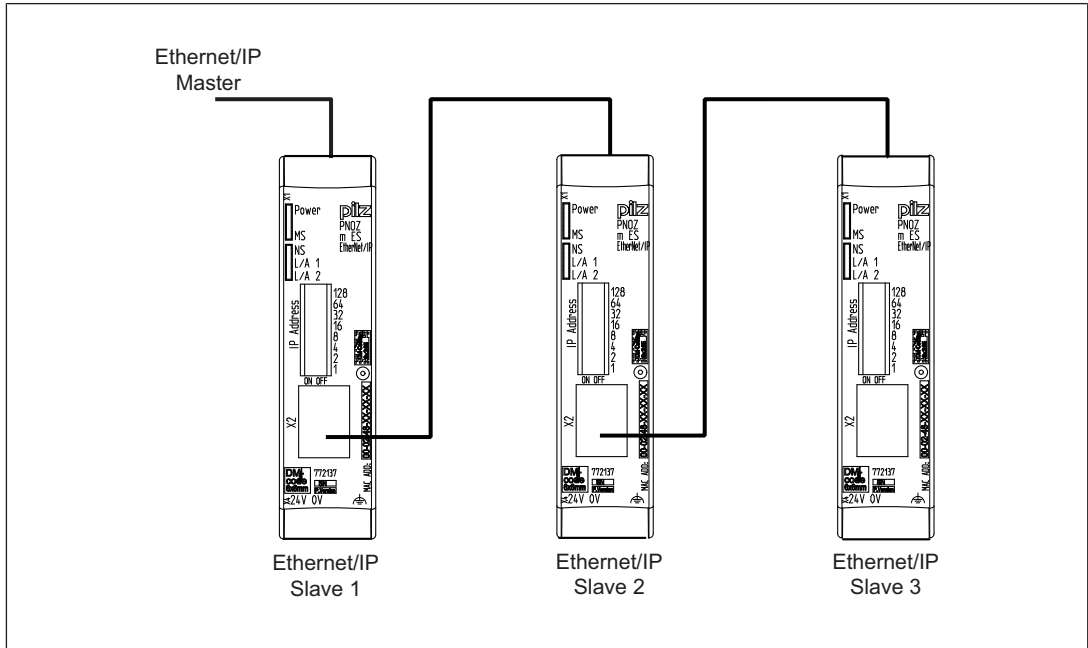

## 7 Operation

When the supply voltage is switched on, the PNOZmulti safety system copies the configuration from the chip card.

The LEDs "POWER", "DIAG", "FAULT", "IFAULT" and "OFAULT" will light up on the base unit.













The fieldbus module PNOZ m ES EtherNet/IP is configured and started automatically. The LEDs "MS", "NS", "L/A1" and "L/A2" indicate the status of the PNOZ m ES EtherNet/IP on the EtherNet/IP.

### 7.1 Messages

Legend:

	LED on
	LED flashes
	LED off

LED	Meaning	
Power	green	Supply voltage is present
		Supply voltage is not present
L/A1	green	Bus connection present at X1 (100 Mbit/s)
	green	Data traffic present at X1 (100 Mbit/s)
	orange	Bus connection present at X1 (10 Mbit/s)
	orange	Data traffic present at X1 (10 Mbit/s)
		Bus connection is not available at X1
L/A2	green	Bus connection present at X2 (100 Mbit/s)
	green	Data traffic present at X2 (100 Mbit/s)
	orange	Bus connection present at X2 (10 Mbit/s)
	orange	Data traffic present at X2 (10 Mbit/s)
		Bus connection not available at X2

LED		Meaning
MS		No supply voltage on PNOZ m ES EtherNet/IP
	 green	The fieldbus module PNOZ m ES EtherNet/IP is operating correctly
	 green	The fieldbus module PNOZ m ES EtherNet/IP is not configured
	 red	Recoverable fault
	 red	Major internal error (not recoverable)
	 green/red	Self test after switching on the supply voltage
NS		No supply voltage present or no IP address assigned
	 green	The fieldbus module PNOZ m ES EtherNet/IP has established at least one connection
	 green	The fieldbus module PNOZ m ES EtherNet/IP has no IP connection
	 red	The connection to the master was interrupted. Remedy: Reconnect.
	 red	IP address is already in use.
	 green/red	Self test after switching on the supply voltage

## 7.2 Web server

A web server is implemented in the fieldbus module PNOZ m ES EtherNet/IP. This can be used to poll data from the PNOZmulti.

- ▶ The web server is started once the PNOZ m ES EtherNet/IP is connected to the supply voltage.
- ▶ The web server is intended for use with Internet Explorer or Firefox.
- ▶ Make sure that Javascript and Cookies are enabled in your browser's security settings.

### 7.2.1 Password administration

- ▶ Two users are preset for access to the web server when the product is delivered.

User	Access type	Password
User	Read-only	1111
User	Read/write	0000

- ▶ A password is required for access.
- ▶ The user names and passwords can be changed.

- ▶ If you change the password and then forget the new password, you will no longer be able to access the fieldbus module PNOZ m ES EtherNet/IP via the web server. In this case you will need to return the module to Pilz for it to be reset to its original delivery status. All settings will be lost in the process.  
So if you have changed the password, make sure that you store the (new) password securely and reliably.
- ▶ **Before** changing the passwords, make sure that the configuration is saved along with the passwords from the delivery status.

## 7.2.2

### Call web server

1. Connect the PNOZ m ES EtherNet/IP to the PC.
2. Call up the HTML page:
  - ***http://192.168.1.xxx***
  - For xxx, enter the value that you have set as the last byte of the IP address.
3. Enter the user name and password correctly and log on to the web server.
4. Select the option you require in the overview and then follow the instructions.

## 8 Technical Details

<b>General</b>	
Approvals	<b>CCC, CE, EAC (Eurasian), cULus Listed</b>
<b>Electrical data</b>	
Supply voltage	
for	<b>Module supply</b>
Voltage	<b>24,0 V</b>
Kind	<b>DC</b>
Voltage tolerance	<b>-20 %/+25 %</b>
Supply voltage	
Current consumption	<b>50 mA</b>
Power consumption	<b>1,2 W</b>
Max. power dissipation of module	<b>1,50 W</b>
Status indicator	<b>LED</b>
<b>Fieldbus interface</b>	
Fieldbus interface	<b>EtherNet/IP</b>
Unit type	<b>Adapter</b>
Transmission rates	<b>10 MBit/s, 100 MBit/s</b>
Connection	<b>2 x RJ45</b>
Galvanic isolation	<b>Yes</b>
<b>Environmental data</b>	
Ambient temperature	
In accordance with the standard	<b>EN 60068-2-14</b>
Temperature range	<b>0 - 60 °C</b>
Forced convection in control cabinet off	<b>55 °C</b>
Storage temperature	
In accordance with the standard	<b>EN 60068-2-1/-2</b>
Temperature range	<b>-25 - 70 °C</b>
Climatic suitability	
In accordance with the standard	<b>EN 60068-2-30, EN 60068-2-78</b>
Condensation during operation	<b>Not permitted</b>
EMC	<b>EN 61131-2</b>
Vibration	
In accordance with the standard	<b>EN 60068-2-6</b>
Frequency	<b>10,0 - 150,0 Hz</b>
Acceleration	<b>1g</b>
Shock stress	
In accordance with the standard	<b>EN 60068-2-27</b>
Acceleration	<b>15g</b>
Duration	<b>11 ms</b>
Max. operating height above sea level	<b>2000 m</b>

<b>Environmental data</b>	
Airgap creepage	
In accordance with the standard	<b>EN 61131-2</b>
Overvoltage category	<b>II</b>
Pollution degree	<b>2</b>
Rated insulation voltage	<b>30 V</b>
Protection type	
In accordance with the standard	<b>EN 60529</b>
Mounting area (e.g. control cabinet)	<b>IP54</b>
Housing	<b>IP20</b>
Terminals	<b>IP20</b>
<b>Potential isolation</b>	
Potential isolation between	<b>Fieldbus and module voltage</b>
Type of potential isolation	<b>Functional insulation</b>
Rated surge voltage	<b>500 V</b>
<b>Mechanical data</b>	
Mounting position	<b>Horizontal on top hat rail</b>
DIN rail	
Top hat rail	<b>35 x 7,5 EN 50022</b>
Recess width	<b>27 mm</b>
Material	
Bottom	<b>PC</b>
Front	<b>PC</b>
Top	<b>PC</b>
–	<b>Green</b>
Conductor cross section with screw terminals	
1 core flexible	<b>0,25 - 2,50 mm<sup>2</sup>, 24 - 12 AWG</b>
2 core with the same cross section, flexible without crimp connectors or with TWIN crimp connectors	<b>0,20 - 1,50 mm<sup>2</sup>, 24 - 16 AWG</b>
Torque setting with screw terminals	<b>0,50 Nm</b>
Connection type	<b>Spring-loaded terminal, screw terminal</b>
Conductor cross section with spring-loaded terminals:	
Flexible with/without crimp connector	<b>0,20 - 2,50 mm<sup>2</sup>, 24 - 12 AWG</b>
Spring-loaded terminals: Terminal points per connection	<b>2</b>
Stripping length	<b>9,0 mm</b>
Dimensions	
Height	<b>101,4 mm</b>
Width	<b>22,5 mm</b>
Depth	<b>110,4 mm</b>
Weight	<b>90 g</b>

Where standards are undated, the 2014-04 latest editions shall apply.

## 9 Order reference

### 9.1 Module

Product type	Features	Order no.
PNOZ m ES EtherNet/IP	Fieldbus module, EtherNet/IP	772 137

### 9.2 Accessories

#### Terminator, jumper

Product type	Features	Order no.
PNOZ mm0.xp connector left	Jumper yellow/black to connect the modules, 1 piece	779 260

#### Connection terminals

Product type	Features	Order no.
Spring terminals PNOZ mmcxp 1 pc.	Spring-loaded terminals, 1 pieces	783 542
Spring terminals PNOZ mmcxp 10 pcs.	Spring-loaded terminals, 10 pieces	783 543
Screw terminals PNOZ mmcxp 1 pc.	Screw terminals, 1 piece	793 542
Screw terminals PNOZ mmcxp 10 pcs.	Screw terminals, 10 pieces	793 543

# ► Support

Technical support is available from Pilz round the clock.

## Americas

Brazil  
+55 11 97569-2804  
Canada  
+1 888-315-PILZ (315-7459)  
Mexico  
+52 55 5572 1300  
USA (toll-free)  
+1 877-PILZUSA (745-9872)

## Asia

China  
+86 21 60880878-216  
Japan  
+81 45 471-2281  
South Korea  
+82 31 450 0680

## Australia

+61 3 95446300

## Europe

Austria  
+43 1 7986263-0  
Belgium, Luxembourg  
+32 9 3217575  
France  
+33 3 88104000  
Germany  
+49 711 3409-444  
Ireland  
+353 21 4804983  
Italy  
+39 0362 1826711

## Scandinavia

+45 74436332

## Spain

+34 938497433

## Switzerland

+41 62 88979-30

## The Netherlands

+31 347 320477

## Turkey

+90 216 5775552

## United Kingdom

+44 1536 462203

You can reach our international hotline on:

+49 711 3409-444

support@pilz.com

Pilz develops environmentally-friendly products using ecological materials and energy-saving technologies. Offices and production facilities are ecologically designed, environmentally-aware and energy-saving. So Pilz offers sustainability, plus the security of using energy-efficient products and environmentally-friendly solutions.

*Energy saving by Pilz*



### The 4-fold safety of automation

COMPONENTS  
SYSTEMS  
SERVICES

Technical Ecological  
Personal Economical



Pilz GmbH & Co. KG  
Felix-Wankel-Straße 2  
73760 Ostfildern, Germany  
Tel.: +49 711 3409-0  
Fax: +49 711 3409-133  
info@pilz.com  
www.pilz.com

**pilz**  
the spirit of safety

CMSE, InduraNET p, PAS4000, PAScal, PASconfig, Pilz, PIT, PLID, PMCPrimo, PMCProtego, PMCTendo, PMD, PMI, PNOZ, Primo, PSEN, PSS, PVIS, Safety SafetyYE, SafetyNET p, the spirit of safety, are registered and protected trademarks of Pilz GmbH & Co. KG in some countries. We would point out that product features may vary from the details stated in this document, depending on the status at the time of publication and the scope of the equipment. We accept no responsibility for the validity, accuracy and entirety of the text and graphics presented in this information. Please contact our Technical Support if you have any questions.