

MV 25

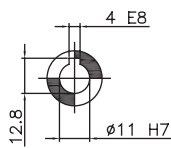

1,08 kg

MV 30

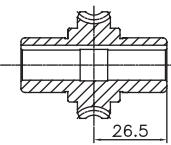
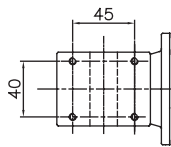
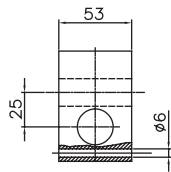
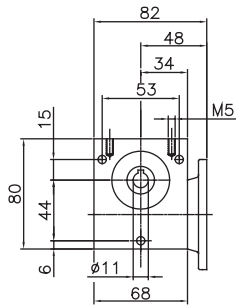
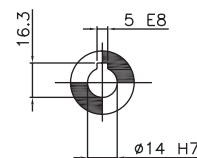
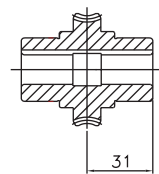
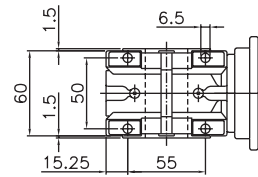
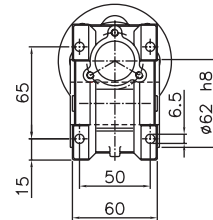
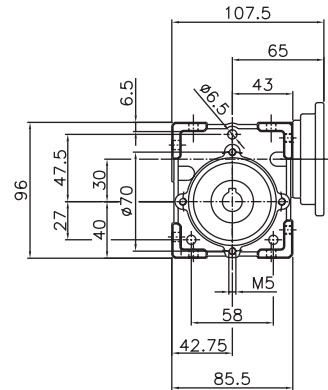

1,33 kg