

Product Information

HD2K-008..025GM / K

**Flow Switch
HD2K**



- High switching power
- Compact design
- viscosity stabilized

Characteristics

Mechanical flow switch, for fluid or gaseous media, with spring-supported piston and magnetic triggering of a reed switch. Robust construction in brass or stainless steel.

Technical data

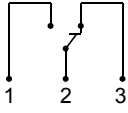
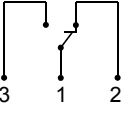
Switch	reed switch	
Nominal width	DN 8..25	
Process connection	female thread G 1/4..G 1 (further process connections available on request)	
Switching range	0,5..60 l/min	for details see table "Ranges"
Pressure loss	1,1..3.5 bar at Q _{max.}	
Q_{max.}	to 80 l/min	
Tolerance	±5 % of full scale value	
Pressure resistance	PN 200 bar optionally PN 500 bar	
Media temperature	-20..+120 °C with display Z -20..+70 °C optionally -20..+150 °C	
Ambient temperature	-20..+70 °C	
Media	oil	
Wiring	changeover No. 0.213  optionally changeover No. 0.282  optionally red or red / green diode in the DIN 43650-A plug	
Switching voltage	max. 175 V DC / 120 V AC	
Switching current	max. 0.25 A DC / 0.18 A AC	
Switching capacity	max. 5 W / VA	
Protection class	2 - Safety insulation	
Ingress protection	IP 65	

Electrical connection	plug DIN 43650-A / ISO 4400 Optionally for round plug connector M12x1, 4-pole	
Materials medium-contact	<i>Brass construction:</i> CW614N nickelled, CW614N, 1.4310, hard ferrite, NBR	<i>Stainless steel construction:</i> 1.4571, 1.4404, 1.4310, hard ferrite PTFE-coated, FKM
Non-medium-contact materials	PA, CW614N, NBR	
Weight	see table "Dimensions and weights"	
Installation location	Standard: horizontal inwards flow from the left; other installation positions are possible; the installation position affects the switching point and range.	

Ranges

For switching ranges, the details in the table correspond to horizontal inwards flow and decreasing flow rate; for display ranges they correspond to horizontal inwards flow and increasing flow rate.

Viscosity compensated type HD2K

Switching range	Optionally Display range	Q _{max.} recommended	Pressure loss bar at Q _{max.} oil mm ² /s					Viscosity stability
			30	60	100	205	330	
l/min oil 30..330 mm ² /s			30	60	100	205	330	±8 %, min.
0.5 - 8	0.5 - 10	12	1.1	1.4	1.6	2.8	3.5	±0.3 l/min
1.5 - 15	1.5 - 20	22	2.2	2.3	2.4			±0.5 l/min
2.5 - 25	2.5 - 30	35	1.9	2.0	2.1	2.3	2.9	±0.8 l/min
6.0 - 40	6.0 - 45	60					2.6	±2.7 l/min
12.0 - 60	12.0 - 65	80	2.1	2.3	2.4	2.6	2.8	±3 l/min

Special ranges are available.

Product Information

HD2K-008..025GM / K

Dimensions and weights

	G	Types	SW	X	Weight kg
Brass	G 1/4	HD.K-008GM	40	15	1.4
	G 3/8	HD.K-010GM			
	G 1/2	HD.K-015GM		18	1.3
	G 3/4	HD.K-020GM			
	G 1	HD.K-025GM			
Stainless steel	G 1/4	HD.K-008GK	41	15	1.3
	G 3/8	HD.K-010GK			
	G 1/2	HD.K-015GK		18	1.2
	G 3/4	HD.K-020GK			
	G 1	HD.K-025GK			

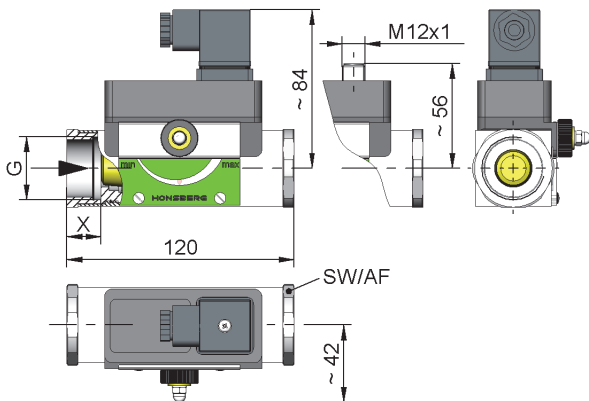

additional weights for options

additional switching head 0.10 kg Display O / Z 0.10 kg
 Display O1 / Z1 0.05 kg

Handling and operation

Note

- Include straight calming section of 5 x DN in inlet and outlet
- If the media are dirty, install a filter (use magnetic filter for ferritic components).
- It must be ensured that the values given for voltage, current, and power are not exceeded.
- When switch on, a load must be connected in series.
- The electrical details apply to ohmic loads. Capacitive, inductive and lamp loads must be operated using a protective circuit.

Adjustment

If it is necessary to set the switching value, the switching head can be adjusted by adjustment of a pinion. When the switching value is reached, the switching unit is fixed in place by a fastening bolt (SW 8).



Ordering code

HD2K 1. 2. 3. 4. 5. 6.
 G

1. Display options	
-	no mechanical display
O1-	with measurement display at side O1
O-	with measurement display at side O
Z1-	with frontal measurement display Z1
Z-	with frontal measurement display Z
2. Nominal width	
008	DN 8 - G 1/4
010	DN 10 - G 3/8
015	DN 15 - G 1/2
020	DN 20 - G 3/4
025	DN 25 - G 1
3. Process connection	
G	female thread
4. Connection material	
M	brass
K	stainless steel
5. HD2K - switching range oil 30..330 mm²/s for horizontal inwards flow	
008	0.5 - 8 l/min
015	1.5 - 15 l/min
025	2.5 - 25 l/min
040	6.0 - 40 l/min
060	12.0 - 60 l/min
6. Special switching head	
A	switching head ATEX A-H1.1 / A-H2.1 / A- H4.1 / A- H4.2 Please order the switching head for -use in addition.

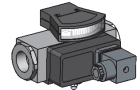

HD.KO1-

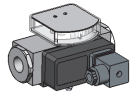

HD.KO-

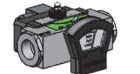

HD.KZ1-

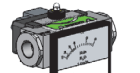

HD.KZ-

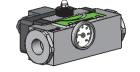

Temperature-display



Options

- Signal lamp red or red / green in the plug DIN 43650-A
- Rhodium contact (250 VAC, 0,5 A, 30 VA)
- SPST N.O.: 250 V DC; 1.5 A; 50 W / 265 V AC; 1.1 A; 50 VA
- Temperature resistant up to 150 °C
- Additional switching head
- Connection for round plug connector M12x1
- High pressure model PN 500 (only if made of brass)
- Adjustment scale with markings in l/min
- Temperature monitoring
- Damping for gas monitoring (only for standard version)
- Special values
- Temperature display 0..120 °C
- Switching head made of metal
- Shock proof with increased switch hysteresis 250 V AC; 1.5 A; 50 VA

Ordering information

- Specify direction of flow, medium, and switching range.
- For viscous media specify viscosity, temperature, and medium (e.g. ISO VG 68) (enquire about switching range).