

# RU300U-M30E-2UP8X2T-H1151

## Ultrasonic Sensor – Diffuse Mode Sensor

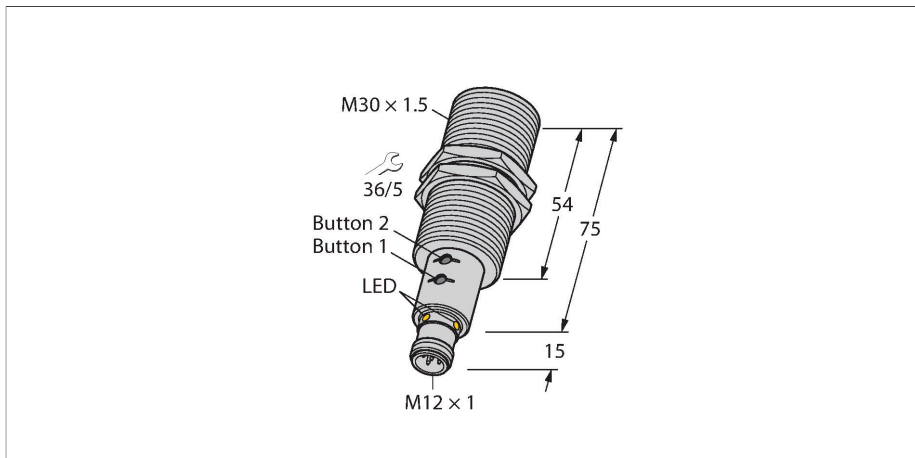

### Technical data

Type	RU300U-M30E-2UP8X2T-H1151
ID	1610040
<b>Ultrasonic data</b>	
Function	Proximity switch
Range	300...3000 mm
Resolution	1 mm
Minimum switching range	25 mm
Ultrasound frequency	120 kHz
Repeat accuracy	≤ 0.15 % of full scale
Temperature drift	± 1.5 % of full scale
Linearity error	≤ ± 0.5 %
Edge lengths of the nominal actuator	100 mm
Approach speed	≤ 11 m/s
Pass speed	≤ 4.2 m/s
<b>Electrical data</b>	
Operating voltage	15...30 VDC
Residual ripple	10 % U <sub>ss</sub>
DC rated operational current	≤ 150 mA
No-load current	≤ 50 mA
Load resistance	≤ 1000 Ω
Residual current	≤ 0.1 mA
Response time typical	< 190 ms
Readiness delay	≤ 300 ms
Output function	NO/NC, PNP
Output 1	Switching output
Output 2	Switching output

### Features

- Smooth sonic transducer face
- Cylindrical housing M30, potted
- Connection via M12 x 1 male
- Measuring range adjustable via teach button/Easy-Teach
- Temperature compensation
- Blind zone: 30 cm
- Range: 300 cm
- Resolution: 1 mm
- Aperture angle of sonic cone: ±15 °
- 2 x switching outputs, PNP
- NO/NC programmable

### Wiring diagram

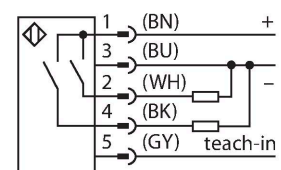

### Functional principle

Ultrasonic sensors capture a multitude of objects contactlessly and wear-free with ultrasonic waves. It does not matter whether the object is transparent or opaque, metallic or non-metallic, firm, liquid or powdery. Even environmental conditions such as spray, dust or rain hardly affect their function. The sonic cone diagram indicates the detection range of the sensor. In accordance with standard EN 60947-5-2, quadratic targets in a range of sizes (20 × 20 mm, 100 × 100 mm) and a round rod with a diameter of 27 mm are used. Important: The detection ranges for other targets may differ from those for standard targets due to the different reflection properties and geometries.

## Technical data

Switching frequency	≤ 3.3 Hz
Hysteresis	≤ 25 mm
Voltage drop at I <sub>e</sub>	≤ 2.5 V
Short-circuit protection	yes / Cyclic
Reverse polarity protection	yes
Wire breakage protection	yes
Setting option	Remote Teach

### Mechanical data

Design	Threaded barrel, M30
Radiation direction	straight
Dimensions	Ø 30 x 89 mm
Housing material	Metal, CuZn, Nickel Plated
Max. tightening torque of housing nut	75 Nm
Transducer material	Plastic, Epoxyd resin and PU foam
Electrical connection	Connector, M12 × 1, 5-wire
Ambient temperature	-25...+70 °C
Storage temperature	-40...+80 °C
Protection class	IP67
Switching state	LED, Yellow
Object detected	LED, Green

### Tests/approvals

MTTF	232 years acc. to SN 29500 (Ed. 99) 40 °C
Declaration of conformity EN ISO/IEC	EN 60947-5-2
Vibration resistance	IEC 60068-2
Approvals	CE cULus

## Sonic Cone

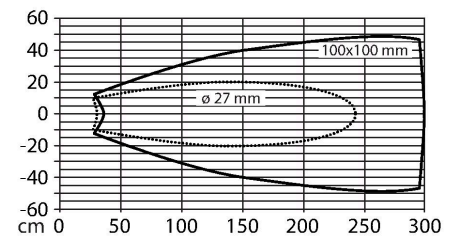

## Mounting instructions

### Mounting instructions/Description

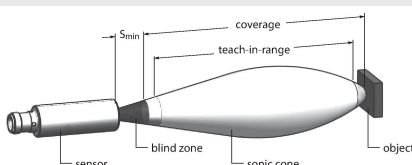

### Setting the limit values

The ultrasonic sensor features two switching outputs with teachable switching ranges. The adjustments can either be made via the Easy-Teach adaptor or via the buttons (please note, only the RU...U-M...E-2UP8X2T-H1151 types have buttons). The green and yellow LEDs indicate whether the sensor has detected the object.

Various functions can be taught, such as single switchpoint, window mode or reflection mode to a fixed target. Further information is described in the operating instructions. How to set the window mode by teaching two limits is described below. These two limits form the switching window and can be selected freely within the detection range.



## Easy-Teach

- Connect teach adaptor TX1-Q20L60 between the sensor and connection cable.
- Position the object for the first limit value.
- Press and hold the button against Gnd for 2 or 8 s to select output 1 or 2.
- Press and hold the button against Gnd for 8 s to teach the first limit value.
- Position the object for the second limit value.
- Press and hold the button against Gnd for 2 s.

- Teach button (please note, only the RU...U-M...E-2UP8X2T-H1151 types have buttons).
- Position the object for the first limit value.
  - Press and hold button 1 against Gnd for 2 or 8 s to select output 1 or 2.
  - Press and hold button 1 for at least 8 seconds.
  - Position the object for the second limit value.
  - Press and hold button 1 for 2 seconds.

After a successful teach-in, the sensor automatically runs in normal operating mode. Unsuccessful teach-in is signaled by the LED flashing slowly at a frequency of 5 Hz.

## LED response

Successful teach-in is indicated by a fast flashing green LED. The sensor then automatically runs in normal operating mode. Unsuccessful teach-in is indicated by the LED flashing alternately green and yellow.

In normal operating mode, both LEDs signal the switching state of output 1.

- Green: Object within the detection range but not in switching range
- Yellow: Object within the switching range
- Off: Object outside the detection range

## Accessories

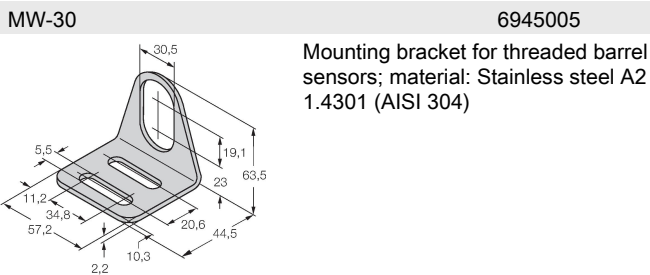

## Accessories

Dimension drawing	Type	ID	
	RKC4.5T-2/TEL	6625016	Connection cable, female M12, straight, 5-pin, cable length: 2 m, sheath material: PVC, black; cULus approval; other cable lengths and qualities available, see www.turck.com

Dimension drawing	Type	ID	
	WKC4.5T-2/TEL	6625028	Connection cable, female M12, angled, 5-pin, cable length: 2 m, sheath material: PVC, black; cULus approval; other cable lengths and qualities available, see <a href="http://www.turck.com">www.turck.com</a>

## Accessories

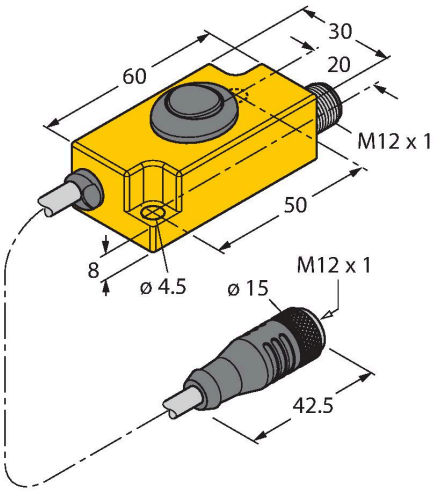
Dimension drawing	Type	ID	
	TX1-Q20L60	6967114	Teach adapter for inductive encoders, linear position, angle, ultrasonic and capacitive sensors